

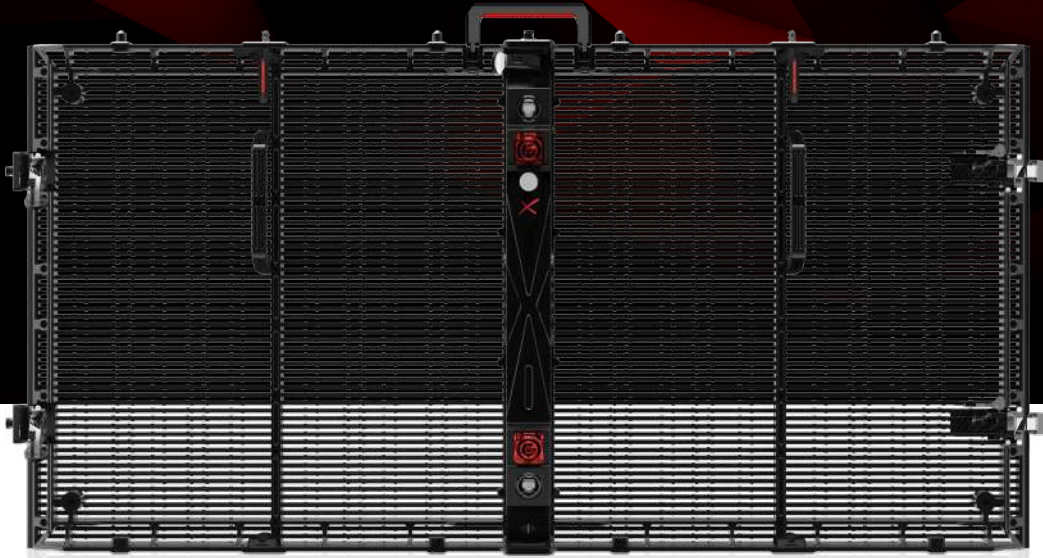

# ORION

TRANSPARENT TOURING LED CABINET













## OVERVIEW

The ORION is our most recent addition to our TRANSPARENT TOURING range. Its many touring-oriented features were designed to ease its installation, uninstallation and transport while offering many integration possibilities. This trustworthy LED cabinet will be a great addition to your rental cabinet fleet. Its transparency and brightness will be of great use for any indoor touring application.



-  **APPLICATION**  
Indoor
-  **BRIGHTNESS**  
≤ 5000 NITS @5volts
-  **INGRESS PROTECTION**  
IP40
-  **WEIGHT**  
7.5 kg/cabinet
-  **PIXEL PITCH**  
P3.9a7.8
-  **MATERIAL**  
Die-casting aluminum
-  **DISPLAY AREA (W x H)**  
1000 x 500 mm
-  **MAINTENANCE**  
Back maintenance



## FEATURES

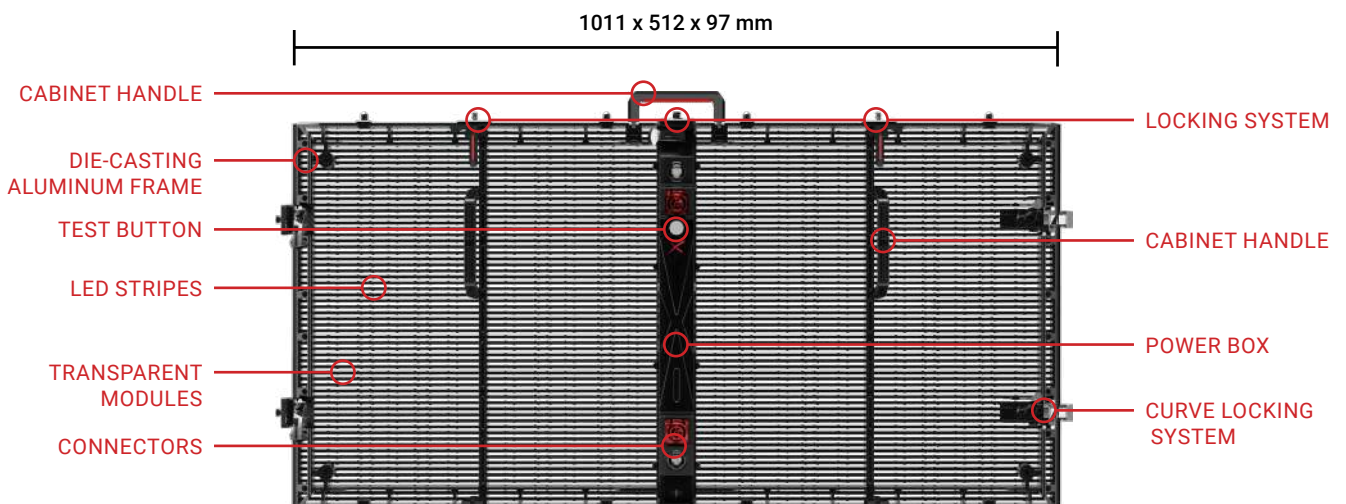

### HIGH BRIGHTNESS

The ORION is able to reach a 5000 NITS brightness, which can be very useful when it comes to event applications. Amongst the many light effects of your stage, the visual content displayed on

your ORION screen will remain clearly visible. When it comes to touring solutions, a high brightness is a clear advantage, as it guarantees visibility in any circumstances.



**INTEGRATED CURVE  
LOCKING SYSTEM**



**INTEGRATED  
CABINET HANDLES**



**BEVELED DESIGN  
AT 45° ANGLES**



### CURVES & ANGLES

The ORION cabinets are beveled at a 45° angle, and come with curve locking systems on the sides that allow you to choose the inward or outward curvature of your LED application up to 90°. This helps create seamless creative curved screens, combined with a certain amount of aesthetic transparency.

### EASY ASSEMBLY

With its light weight, cabinet handles and toolless locking systems, the ORION is very quick and easy to install. A cabinet can be managed by one man, making it very convenient to integrate or move your cabinet fleet to your needs.

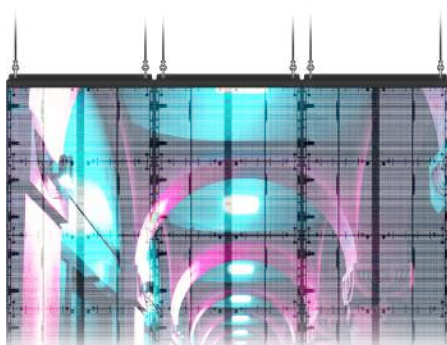
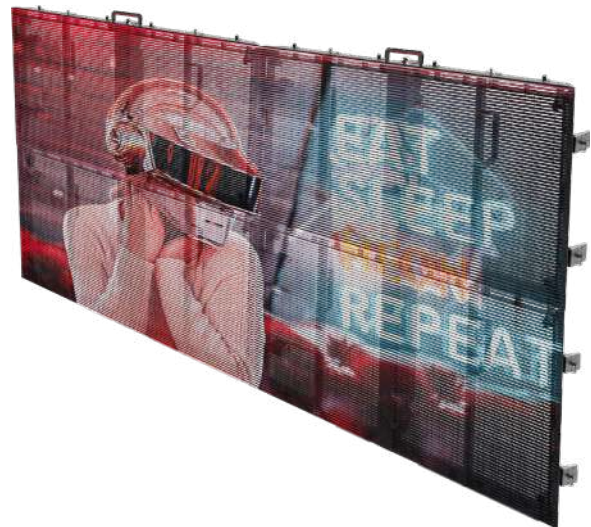

### CREATIVE APPLICATIONS

As for many touring LED cabinets, the only limitation to what kind of screen you can build is your imagination. This is helped by the many accessories available (hanging bars, trusses, etc.).



## TECHNICAL SPECIFICATIONS

		INDOOR
Product Parameters	Unit	3.9a7.8
Pixel Pitch	mm	3,91 x 7,81
LED		SMD1921
Application		Transparent rental LED cabinet
Ingress Protection	IP	IP40
Brightness	cd/sqm	≤ 5000 Nits @5volts
Color Temperature after calib (adjustable)	deg. K	6500
Viewing Angle (50% brightness)	deg.	160 H / 160 V
Cabinet Size (WxHxD)	mm	1011 x 512 x 97
Display area (WxH)	mm	1000 x 500
Module Size (WxHxD)	mm	500 x 125 x 10
Pixel Matrix Per Cabinet (WxH)	px	256 x 64
Pixel Matrix Per Module (WxH)	px	128 x 16
Pixel Density	px/sqm	32768
Weight of cabinet and modules	kg	7.5
Cabinet Material		Die-casting aluminum
Maintenance Mode		Back
Mask specification		95% Plastic + 5% Fiber / SS Screws / No shaders
Contrast Ratio		High
Grey scale (linear)	bit	16
Brightness control	bit	16
Processing depth	bit	16
Color		281 Trillions
Display Refresh Rate	Hz	3840
Operation Power	V	AC85-230V
Max. Power Consumption	W/sqm	800
Average Power Consumption	W/sqm	400
Control Mode		Synchronization
Video Frame Rate	Hz	50/60Hz
Input Types Supported		DVI / SDI / HDMI
3D ready (optional)		Yes
Calibration		Yes
Lifetime (50% brightness)	h	50000
Operating Humidity Range		10-60%
Operating Temperature Range		-40°C / +45°C
Screen Uniformity Correction		-
Certification		CE / ETL / CCC
Options		
Compatibility		No



## TECHNICAL DRAWINGS

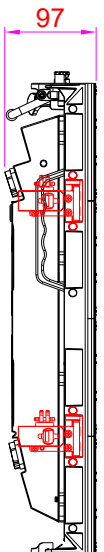
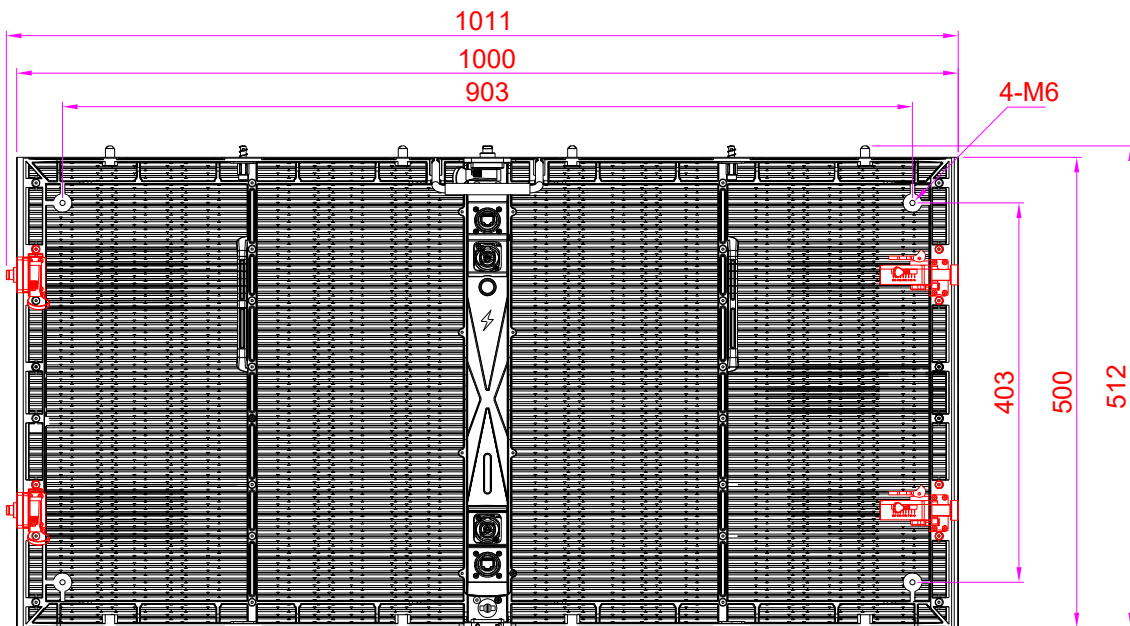
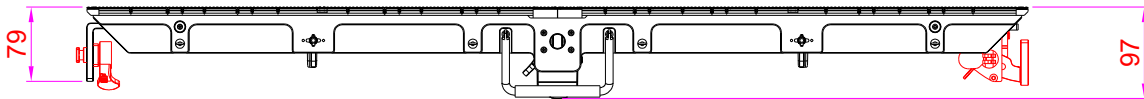
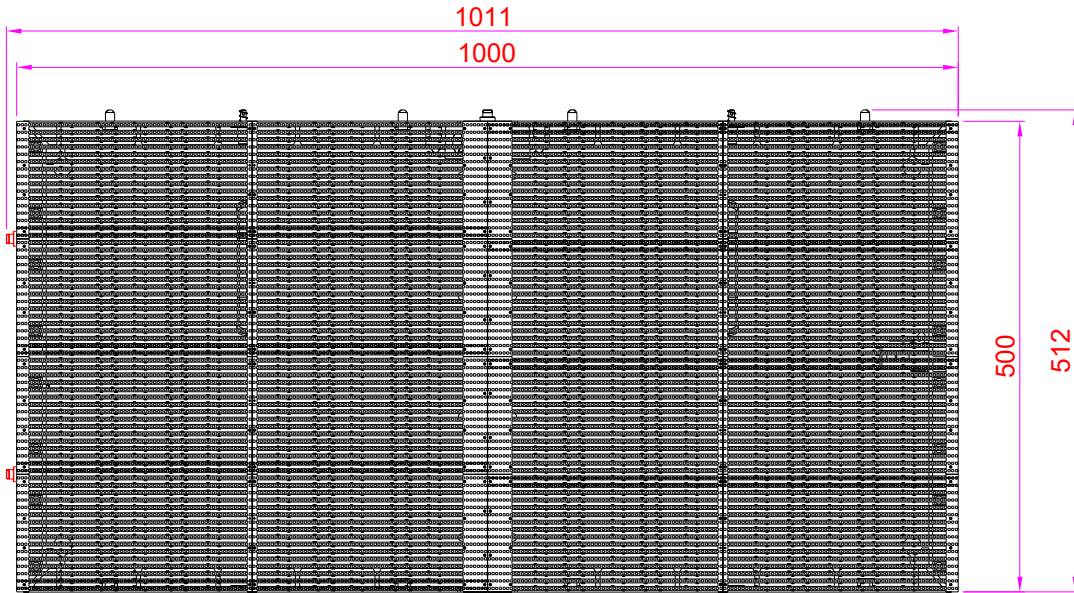



# CONTACT

The Artixium regional branches are the key for the growth and development of our global network all over the world. Artixium's team is a spectrum of different nationalities and cultures, reflecting their global presence and mindset, mak-

ing their communication smooth and hassle-free with clients from all around the world. Customer care, Innovation and flexibility has always been our values and we intend to keep this reputation for many years to come.

## ARTIXIUM FRANCHISES

*"From your project's conception to its completion."*



112 Avenue Franklin Roosevelt  
69120 Vaulx-en-Velin  
France



Artixium Operational Center  
518000 Shenzhen  
China



Weissensteinstrasse 90b,  
46149 Oberhausen  
Germany



Merkez Mah. Baglar Cad. A  
Blok Apt. No: 14D/13 Kagithane, Istanbul  
Turkey



 [www.artixium.com](http://www.artixium.com)

 0 428 001 801

 [linkedin.com/company/artixium](https://www.linkedin.com/company/artixium)

 [twitter.com/artixium](https://twitter.com/artixium)

 [contact@artixium.com](mailto:contact@artixium.com)

 [youtube.com/@artixium](https://www.youtube.com/@artixium)

 [facebook.com/artixium](https://www.facebook.com/artixium)

 [instagram.com/artixium](https://www.instagram.com/artixium)



Since its creation in 2012 by two european entrepreneurs, Artixium has been evolving and always looking for innovative ways to contribute to the digital transition of our world. It only took a few years for Artixium to become a key player in the LED display industry.

---

[www.artixium.com](http://www.artixium.com)